

Công Ty TNHH Thiết Bị Tự Động BẢO PHÁT

Điện thoại: 0904 668 997

E-mail: automaticgatevn@gmail.com

Website: <https://automaticdoor.vn>

Địa chỉ: 40/4H Đông Lân – Hưng Lân, Bà Điểm, Hóc Môn, Tp. Hồ Chí Minh.



EL-888A (Auto gate)

General Description

eLock EL-888A is an electro-mechanical complete system for automatic swing gate. It is composed primarily of an electronic panel unit that control actuator motor to open or close the gate in a swing motion. EL888A has been carefully designed and thoroughly tested for Malaysia extreme weather condition. Its performance is continuously refined by 15 years of experience. Our stringent quality control guarantees the consistency and reliability of eLock swing gate system.

Features

- Residential home with single gate leaf weight not exceeding 300 kg.
- Good quality. eLock system major components are made of top grade tough, durable and rust resistance material.
- Fast and silent. The actuator is capable for 90° opening within only 7 to 10 seconds and is exceptionally quiet in operation.
- Last longer. Gear box is submerged in oil bath for more protection. This design significantly improves the actuator's mechanical life span.
- Secure. DC powered lock ensures that there is no unauthorized opening of the gate. The gate can only be opened with the remote control transmitter or special key (during power failure).
- Safe. Fully DC operation to avoid any potential electric hazard.
- Convenient. Remote control coded transmitter allow convenient operation for user in the vehicle within 30 to 50 meters from the gate.
- Intelligent. Smart microprocessor is used in the control panel. Can be upgraded to support standby battery in case of power failure.
- Gate leaf operation with cushioning – gate will slow down towards the end of opening or closing swing. This is to avoid the gate banging loudly into the stopper and pillar light wall at high speed.

Công Ty TNHH Thiết Bị Tự Động BẢO PHÁT

Điện thoại: 0904 668 997

E-mail: automaticgatevn@gmail.com

Website: <https://automaticdoor.vn>

Địa chỉ: 40/4H Đông Lĩnh – Hưng Lĩnh, Bà Điểm, Hóc Môn, Tp. Hồ Chí Minh.

System Package

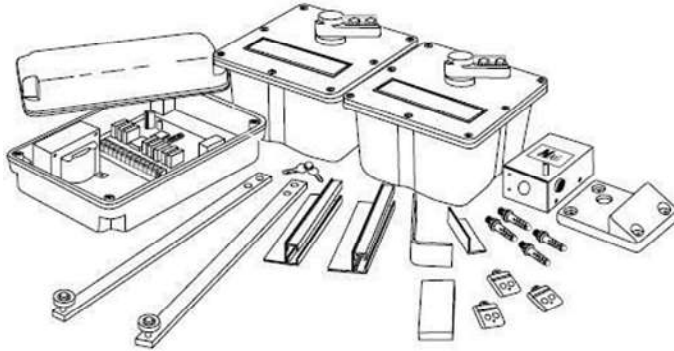

System package consist of the following:

- 2pcs elock swing gate actuator
- 1set Lock solenoid lock & stopper
- 2pcs Key for manual release
- 2set Actuator arm & bracket
- 1set Control panel c/w transformer
- 1pcs ABS weather resistant plastic casing
- 1set Remote control c/w 3 transmitter

Technical Specification – Actuator

A rotary drive unit complete with DC motor, speed reducer and electro-mechanical system housed in a waterproof rust resistance cast alloy casing. Actuator drives the gate leaf to move.



Motor voltage rating	12 - 24 VDC
Power Consumption	120 watt per actuator
Trust force	0 to 60 kg
Max Opening angle	360°
Max leaf weight allowable	300 kg
Motor rated load speed	4700 RPM
Actuator output speed	2.2 RPM
Traveling speed	7 – 10 sec for 90°
Dimension	256mm x 245mm x 155mm

Power supply input: AC 230 Vac+/- 10%. Available DC12V and 24V output for actuator. Integrated power surge arrestor to protect against lightning strike.

Công Ty TNHH Thiết Bị Tự Động BẢO PHÁT

Điện thoại: 0904 668 997

E-mail: automaticgatevn@gmail.com

Website: <https://automaticdoor.vn>

Địa chỉ: 40/4H Đông Lĩnh – Hưng Lĩnh, Bà Điểm, Hóc Môn, Tp. Hồ Chí Minh.

Technical Specification – Control Panel

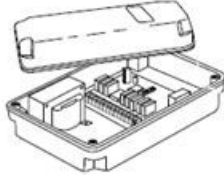

Consists of an advanced microprocessor based PCB, and transformer housed in weather resistant casing. Controls operation of the whole swing auto gate system.

Functions:

- Dual Speed gate Control
- Gate leaf opening and closing with cushioning
- Automatic pillar light control
- Single or two gate leaf open; selectable from remote control transmitter or in house pushbutton.
- Adjustable opening/closing angle.
Gate can be stopped immediately and resume motion at any angle
- LED indication
- Casing is made from weather proof ABS plastic. Casing dimension 320mm x 250mm x 150mm

Technical Specification – Remote control & transmitter

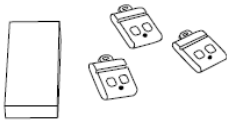

Range	Effective 30m. Max 50m
Transmitter dimension	52mm x 35mm x 12mm
Receiver dimension	95mm x 95mm x 30mm

Consist of a receiver and transmitters. Allows gate operation to be controlled remotely within the specified range.

Modulated RF transmission:

Transmission coding (6561 combinations) is set by 8x3 DIP switched in the receiver and transmitter – easily accessible and changed by owner. Coding on both sides must be the same for it to work.

Receiver:

Receiver is installed inside the ABS casing together with control panel. Transmitter uses a single 12V small size alkaline battery- normal usage should last 6 months. First button for full open and second button for half open.

Công Ty TNHH Thiết Bị Tự Động BẢO PHÁT

Điện thoại: 0904 668 997

E-mail: automaticgatevn@gmail.com

Website: <https://automaticdoor.vn>

Địa chỉ: 40/4H Đông Lĩnh – Hưng Lĩnh, Bà Điểm, Hóc Môn, Tp. Hồ Chí Minh.

Technical Specification – Solenoid lock

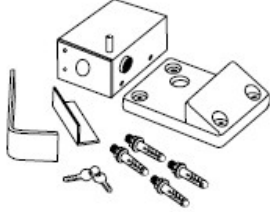

Consist of a solenoid lock, stopper, keys, L-bar, angle bar and 4 set anchors.

It automatically locks the gate when it is closed.

Rated voltage	12 ~24V DC
Locking stopper	Solid mild steel coated with hard PVC
Manual override	Key operated cam-lock to enable manual operation in the event of power failure
Solenoid lock dimension	140mm x 80mm x 70mm

Technical Specification – Actuator Arm & Bracket

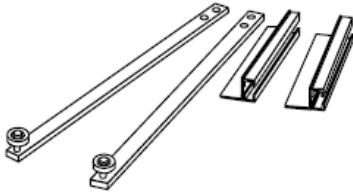

Consist of two arms and two brackets. These are the supporting component that connects the gate to the actuator output shaft. Both are made from good material: Nickel-Chrome plated mild steel.

Arm's dimension: 460mm x 25mm x 5mm

Công Ty TNHH Thiết Bị Tự Động BẢO PHÁT

Điện thoại: 0904 668 997

E-mail: automaticgatevn@gmail.com

Website: <https://automaticdoor.vn>

Địa chỉ: 40/4H Đông Lân – Hưng Lân, Bà Điểm, Hóc Môn, Tp. Hồ Chí Minh.

User Guide – Wiring and installation Diagram

This wiring diagram only shows correct point-to-point electrical connection. It does not represent the underground wiring path in actual installation. Underground wirings are protected by PVC conduits.

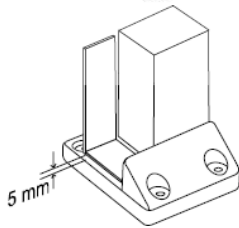
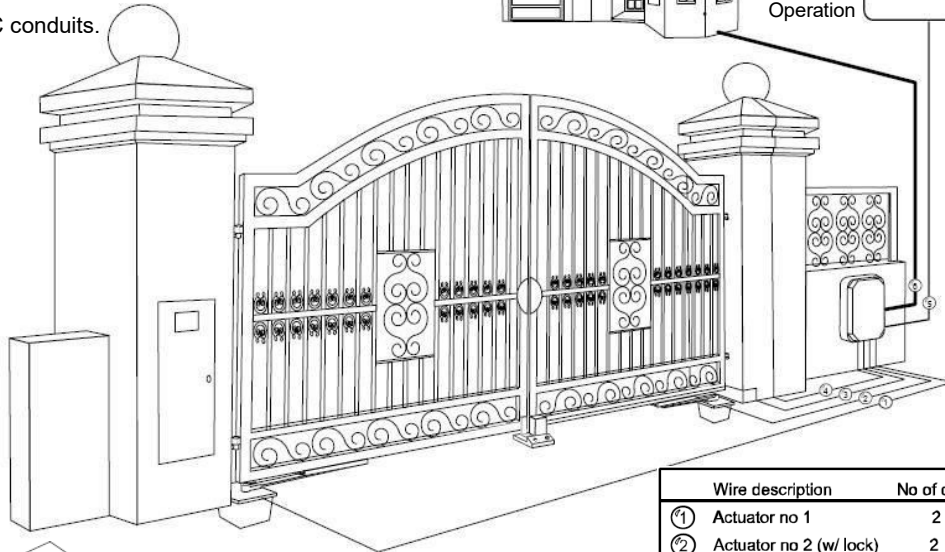
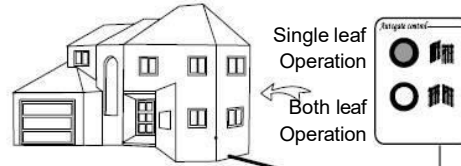

Solenoid lock and L-bar must maintain 5mm gap above the stopper surface to avoid damaging the rubber coating

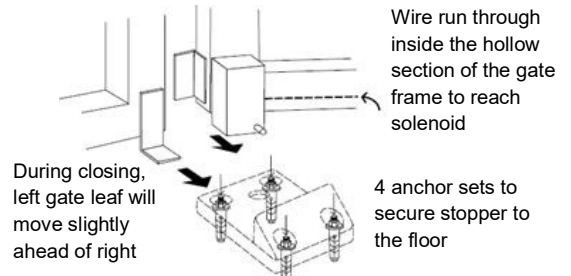
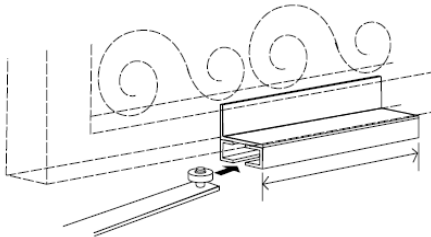

During closing, left gate leaf will move slightly ahead of right

Wire run through inside the hollow section of the gate frame to reach solenoid

4 anchor sets to secure stopper to the floor

The purpose of the bracket is to contain the arm's bearing roller movement as the gate open/close. The bracket mounted should be able to completely include the maximum travelling path of the roller bearing as the gate swing from fully close to fully open position.

The final position of the bracket varies depending on the installation site –and it has to be measured again for every new installation. Failure to mount the bracket accurately will caused bearing roller to fall out when gate is fully open or fully close.

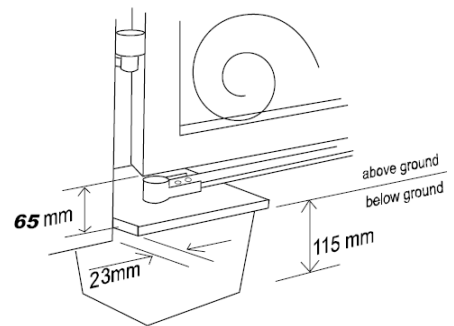

Công Ty TNHH Thiết Bị Tự Động BẢO PHÁT

Điện thoại: 0904 668 997

E-mail: automaticgatevn@gmail.com

Website: <https://automaticdoor.vn>

Địa chỉ: 40/4H Đông Lĩnh – Hưng Lĩnh, Bà Điểm, Hóc Môn, Tp. Hồ Chí Minh.

User Guide – AGC3K Control Panel Manual

Caution:

The installer, the owner and/or operator of this system should read and understand this installation manual and the safety instructions provided. This information should be retained by the owner and/or operator of the gate.

Warning! To reduce the risk of injury or death

1. READ AND FOLLOW ALL INSTRUCTIONS
2. Never let children operate or play with gate controls. Keep the remote control away from children.
3. SAVE THESE INSTRUCTIONS

Introduction:

The AGC3K consists of advance microprocessor based PCB that operates as the core monitoring panel of the automatic gate system.

The AGC3K features included:

- Dual speed control for the gate opening and closing operation
- Gate leaf opening and closing with cushioning
- Automatic pillar light control
- Single or two gate leaf open; selectable from remote control transmitter or in house push button
- Adjustable opening/closing angle. Gate can be stopped immediately and resume motion at any angle
- LED indication
- Power supply input: AC 230VAC +/-10%
- Available DC 12V & 24V output for actuator
- Consists integrated power surge arrestor to protect against lightning strike.

Công Ty TNHH Thiết Bị Tự Động BẢO PHÁT

Điện thoại: 0904 668 997

E-mail: automaticgatevn@gmail.com

Website: <https://automaticdoor.vn>

Địa chỉ: 40/4H Đông Lĩnh – Hưng Lĩnh, Bà Điểm, Hóc Môn, Tp. Hồ Chí Minh.

Function Description:

LED Indications:

- CPU, D15 : blinking when power is ON
- 2SIDE, D6 : light up upon button pressed for opening or closing 2 gates
- 1SIDE, D7 : light up upon button pressed for opening or closing 1 gate
- PHOTO BEAM, D8:
 - If Photo Beam Jumper (J5) is enabled:
Light up when no object is detected with the detection ray (if available).
The LED will turn OFF when object is detected
 - If Photo Beam Jumper (J5) is disabled: Light up at all time
- Red LED, D13 : light up when gates closing
- Green LED, D14 : light up when gates opening
- Red LED, D16 : fully light up when gate 1 is under overloaded condition
- Red LED, D17 : fully light up when gate 2 is under overloaded condition

Jumper Indications:

- J1, Light Delay Jumper (Default: DLY):
 - J1 enabled (DLY) – the light (if available) will turn ON and remain ON when the gate is opened. When the gate closed, the light will remained ON for 30 seconds before turning OFF.
 - J1 disabled (FLW) – the light (if available) will turn ON only for the duration of the gate swings open/close.
- J2, Half Way Swing (HWS) Jumper (Default: HWS):
 - J2 enabled (OP/CL) – when the control is being pressed when the gate is swinging half-way, it will immediately swing in reverse direction.
 - J2 disabled (HWS) – when the control is being pressed when the gate is swinging half-way, it will stop moving. The gate will swing in reverse direction when the control is pressed again.
- J3, Open Reverse Jumper (Default: ON):
 - J3 enabled (ON) – the gate will reverse slightly upon opening
 - J3 disabled (OFF) – the gate will open normally

Công Ty TNHH Thiết Bị Tự Động BẢO PHÁT

Điện thoại: 0904 668 997

E-mail: automaticgatevn@gmail.com

Website: <https://automaticdoor.vn>

Địa chỉ: 40/4H Đông Lĩnh – Hưng Lĩnh, Bà Điểm, Hóc Môn, Tp. Hồ Chí Minh.

- J4, Auto Close Jumper (Default: OFF):
 - J4 enabled (30S) – the opened gate will automatically close after 30 seconds.
 - J4 disabled (OFF) – the opened gate will remain open until the close button is pressed.
- J5, Photo Beam Jumper (Default: OFF):
 - J5 enabled (ON) – the gate will sense with photo beam to check if there is object blocking in the path of the closing gate. If object is detected, the gate will reopen and remain open as long as the object is still in the detection path.
 - J5 disabled (OFF) – the gate operates as usual.

Rheostat Indications:

- M1, M2 – controls the force detection capacity or how much force is required to stop the gate, the gate will stop moving when contacted an object in the opening/closing path.
- TOTAL TIME – controls the total time taken for the door to open/close.
- OPEN HIGHSPEED – determines the time for the gate to swing open at fast speed before changing to slow speed.
- CLOSE HIGHSPEED – determines the time for the gate to swing close at fast speed before changing to slow speed.
- MOTOR2 DELAY – provides a delay respond time for motor 2 (gate 2).

Công Ty TNHH Thiết Bị Tự Động BẢO PHÁT

Điện thoại: 0904 668 997

E-mail: automaticgatevn@gmail.com

Website: <https://automaticdoor.vn>

Địa chỉ: 40/4H Đông Lĩnh – Hưng Lĩnh, Bà Điểm, Hóc Môn, Tp. Hồ Chí Minh.

User Guide – Installation

1. If you have any enquiry or questions about the safety of the automatic gate system, do not attempt to install this autogate. Consult the autogate manufacturer for assistance.
2. Only qualified personnel should install this equipment. Failure to meet this requirement could cause severe injury and even death, for which the manufacturer will not hold responsible.
3. The installer must provide a main power switch that meets all applicable safety regulations.
4. Devices such as reversing edges and photocells must be installed to provide better protection for personal property and pedestrians. Install reversing devices that are appropriate to the gate design and gate application. (Sold separately)
5. Before applying electrical power, be sure that the voltage requirements of the equipment correspond to your supply voltage. Refer to the label on your auto-gate system.
6. Use this equipment only in the capacity for which it was designed. Any use other than the stated specification is not advisable and is considered dangerous.
7. Please observe some fundamental rules when using any electrical equipment:
 - a. Do not touch the equipment with damp or humid hands or feet.
 - b. Do not install or operate the equipment with bare feet.
 - c. Do not allow children or unqualified personnel using this device.
8. Turn off the main power before making any attempt to repair the gate system.
9. The system might reach high temperatures during operation; therefore, please be cautious when attempting to remove or even touch the external housing of the operator.
10. Disconnect the system from the power supply before making any cleaning or maintenance procedures.
11. The manufacturer recommends that the system is being inspect and maintained by a qualified personnel periodically to ensure the efficiency and safety of this device.

Công Ty TNHH Thiết Bị Tự Động BẢO PHÁT

Điện thoại: 0904 668 997

E-mail: automaticgatevn@gmail.com

Website: <https://automaticdoor.vn>

Địa chỉ: 40/4H Đông Lân – Hưng Lân, Bà Điểm, Hóc Môn, Tp. Hồ Chí Minh.

User Guide – Operating Instruction

1. Press and release the push button on the remote control to open the automatic gate. The gate will slide open and stops at the open limit.
2. Press and release the remote control again to close the automatic gate.
3. If the remote control is pressed while the gate is moving, it will stop.
4. Press the remote control again to set the gate moving at reverse direction.
5. The system is integrated with force sensing device, which will prevent the gate from moving once an object with appropriate amount of force is contacted.

User Guide – Wiring Diagram

